

LTR-S Specification Series

1.5W / 3W COB (Chip On Board) LED Tape Specification Sheet



Project Name	Type
Catalog #	Date

PRODUCT OVERVIEW

The newest technology in flexible LED tape is the COB (Chip On Board). Tightly spaced diodes are encapsulated into a single phosphor strip that provides a seamless linear light display with no LED pixelation. Available in 2700K, 3000K, 3500K and 4000K.



FEATURES

- 24VDC
- 2700K, 3000K, 3500K and 4000K color temps
- Remote control with GM's LUXcontrol™ App and controllers
- Dry location
- 156 LEDs per foot
- Cuttable every 2"
- 180° viewing angle
- Dimmable
- 3M adhesive back
- Maximum run on a given lead is 32'-8"
- Includes Sure-Tite connectors



SPECIFICATIONS

ELECTRICAL

- 24V
- 1.5 / 3 watts per foot

OPTICS

- 95+ CRI

OPERATING TEMP

- -4°F to 122°F

CERTIFICATION

- UL
- Title 24 compliant when used with specific drivers. Consult factory.
- Closet Rated: Complies with NEC code (NFPA70) 410.16, Suitable for installation within the clothes closet storage space.

WARRANTY

- 5-year warranty when paired with GM power supply.

ORDERING INFORMATION

Example: LTR-S-COB-24V-3.0W-27K-16

Model	Series	Type	Voltage	Wattage	Color Temp	Reel Length
LTR	S	COB	24V	1.5W	27K	16
					30K	
				3.0W	35K	100
					40K	

Reel Length: 16 = 16'-4", 100=98'-6"

ACCESSORIES

Model	Description
ESTC-1	Sure-Tite tape to tape connector
ESTC-90	Sure-Tite 90° connector
ESTLK-60	Sure-Tite 60" adjustable tape to tape connector
ESTW-60	Sure-Tite 60" adjustable tape to power connector
ESTW-CO	Sure-Tite tape to power supply connector (no wire)

Your LED Tape Specification Checklist:

1. Select Tape
2. Select Connectors
3. Select Channels
4. Select Controllers or Dimmers
5. Select Power Supplies

Install Sheet



LTR-S Specification Series

1.5W / 3W COB (Chip On Board) LED Tape Specification Sheet



Catalog No.	Length	Lumens	CRI	Color Temp.	Max. Run
LTR-S-COB-24V-1.5W-27K-16	16'-4" / 5M	127	95+	2700K	32'-8"
LTR-S-COB-24V-1.5W-30K-16	16'-4" / 5M	127	95+	3000K	32'-8"
LTR-S-COB-24V-1.5W-35K-16	16'-4" / 5M	127	95+	3500K	32'-8"
LTR-S-COB-24V-1.5W-40K-16	16'-4" / 5M	142	95+	4000K	32'-8"
LTR-S-COB-24V-1.5W-27K-100	98'-6" / 30M	127	95+	2700K	32'-8"
LTR-S-COB-24V-1.5W-30K-100	98'-6" / 30M	127	95+	3000K	32'-8"
LTR-S-COB-24V-1.5W-35K-100	98'-6" / 30M	127	95+	3500K	32'-8"
LTR-S-COB-24V-1.5W-40K-100	98'-6" / 30M	142	95+	4000K	32'-8"
LTR-S-COB-24V-3.0W-27K-16	16'-4" / 5M	255	95+	2700K	32'-8"
LTR-S-COB-24V-3.0W-30K-16	16'-4" / 5M	265	95+	3000K	32'-8"
LTR-S-COB-24V-3.0W-35K-16	16'-4" / 5M	275	95+	3500K	32'-8"
LTR-S-COB-24V-3.0W-40K-16	16'-4" / 5M	285	95+	4000K	32'-8"
LTR-S-COB-24V-3.0W-27K-100	98'-6" / 30M	255	95+	2700K	32'-8"
LTR-S-COB-24V-3.0W-30K-100	98'-6" / 30M	265	95+	3000K	32'-8"
LTR-S-COB-24V-3.0W-35K-100	98'-6" / 30M	275	95+	3500K	32'-8"
LTR-S-COB-24V-3.0W-40K-100	98'-6" / 30M	285	95+	4000K	32'-8"

Kelvin temperature (color) $\pm 100K$.

16'-4" and 98'-6" reel includes 48" lead affixed to tape. 16'-4" reel includes (3) ESTW-60 Sure-Tite connectors. 98'-6" reel includes (10) ESTW-60 Sure-Tite connectors.

DIMENSION

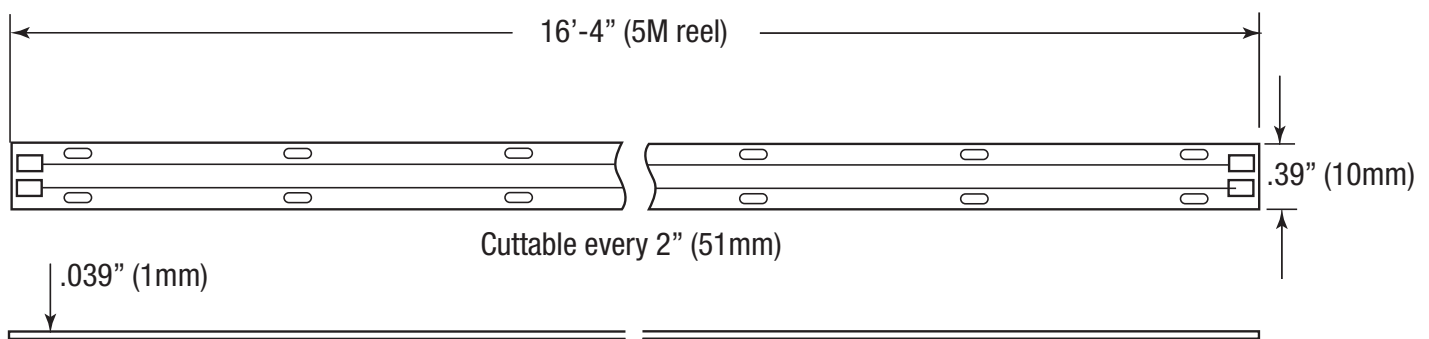

LTR-S Specification Series

1.5W / 3W COB (Chip On Board) LED Tape Specification Sheet

EST SERIES CONNECTORS

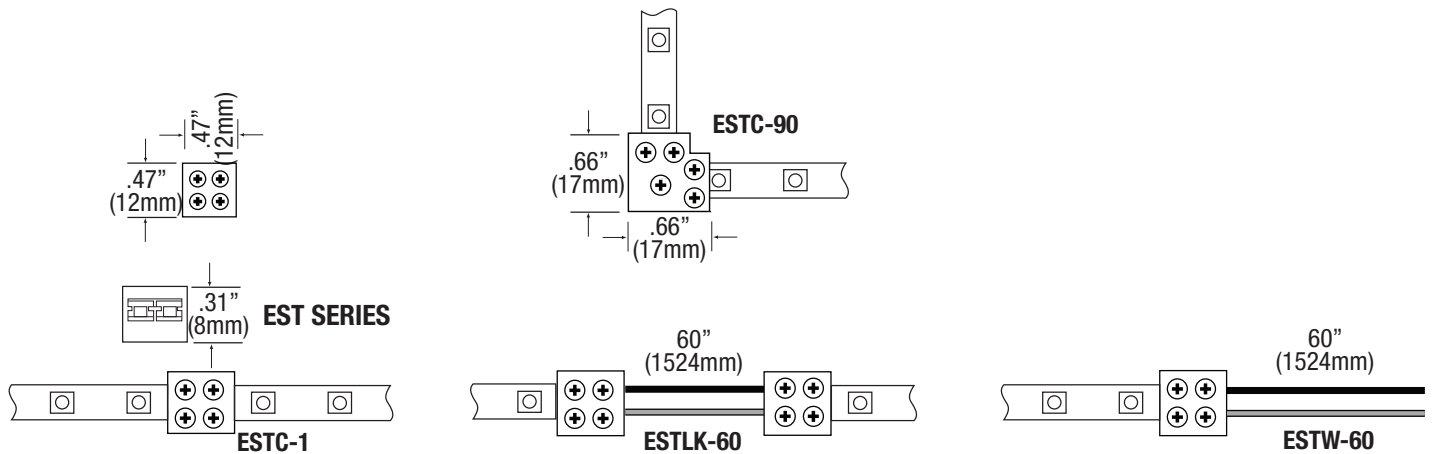

COMPATIBLE CONTROLLERS

Model	Description
SHWC	LUXcontrol Smart 2.4 GHz WiFi Controller, Standard 12V/24V Low Voltage
SHWD	LUXcontrol Smart 2.4 GHz WiFi Dimmer, Standard 12V/24V Low Voltage
SWD-60W-24VDC-DIM	SwitchLD All-in-One Dimmer and Driver, 60W, 24VDC
SWD-100W-24VDC-DIM	SwitchLD All-in-One Dimmer and Driver, 100W, 24VDC
HC-RF-UNV-5CH	Universal 1-5 Channel RF Remote Control
CM-RF-UNV-5CH	Universal 1-5 Channel Control Module
RPT-UNV-5CH	Universal 1-5 Channel Repeater Amplifier

RECOMMENDED DRIVERS

Catalog No.	Description	Watts	Specification Sheet
LD-XD-UNV	LineDrive Electronic Multi-Dimmable Power Supply, 12VDC or 24VDC	20W, 40W, 60W, 96W, 180W, 200W, 300W	View Spec Sheet
LD-E-UNV	LineDrive Electronic Non-Dimmable Power Supply, 12VDC or 24VDC	30W, 60W, 96W, 200W, 300W	View Spec Sheet
LD-MD-UNV	LineDrive Magnetic Dimmable Power Supply, 12VDC or 24VDC	30W, 60W, 96W, 150W, 200W, 300W	View Spec Sheet
LTP	Cord and Plug Power Supply, 12VDC or 24VDC	25W, 48W, 60W, 90W	View Spec Sheet
PSD	Electronic Dimmable Power Supply, 12VDC or 24VDC	15W, 24W, 60W, 90W	View Spec Sheet

Please see our website for updated power supply specifications and information.

LTR-S Specification Series

1.5W / 3W COB (Chip On Board) LED Tape Specification Sheet



COMPATIBLE CHANNELS - FIT CONNECTORS ON PG. 1

EXTRA DEEP

Catalog No.	Description	Length	Dimensions
LED-CHL-XD	Extra deep format extruded channel. Includes snap-on frosted lens with mounting clips and screws.	4'	
LED-CHL-XD-6	Extra deep format extruded channel. Includes snap-on frosted lens with mounting clips and screws.	6'	
LED-CHL-XD-AMC	(2) Adjustable mounting brackets for LED-CHL-XD	N/A	
LED-CHL-XD-EC	(2) End caps for LED-CHL-XD. One solid, one with hole.	N/A	
LED-CHL-XD-MC	(2) Mounting clips and screws for LED-CHL-XD	N/A	

EXTRA DEEP FLANGED

LED-CHL-XD-F	Extra deep format extruded channel with flange. Includes snap-on frosted lens with mounting clips and screws.	4'	
LED-CHL-XD-F-6	Extra deep format extruded channel with flange. Includes snap-on frosted lens with mounting clips and screws.	6'	
LED-CHL-XD-F-DC	(2) Drywall mounting brackets for LED-CHL-XD-F	N/A	
LED-CHL-XD-F-EC	(2) End caps for LED-CHL-XD-F. One solid, one with hole.	N/A	

MINI DEEP

LED-CHL-XD-MD	Mini deep format extruded channel. Includes snap-on frosted lens with mounting clips and screws.	4'	
LED-CHL-XD-MD-WH	Mini deep format extruded channel. Includes snap-on frosted lens with mounting clips and screws. White.	4'	
LED-CHL-XD-MD-B	Mini deep format extruded channel. Includes snap-on frosted lens with mounting clips and screws. Black.	4'	
LED-CHL-XD-MD-6	Mini deep format extruded channel with flange. Includes snap-on frosted lens with mounting clips and screws.	6'	
LED-CHL-XD-MD-6-WH	Mini deep format extruded channel. Includes snap-on frosted lens with mounting clips and screws. White.	6'	
LED-CHL-XD-MD-6-B	Mini deep format extruded channel. Includes snap-on frosted lens with mounting clips and screws. Black.	6'	
LED-CHL-XD-MD-AMC	(2) Adjustable mounting brackets for LED-CHL-XD-MD	N/A	
LED-CHL-XD-MD-EC	(2) End caps for LED-CHL-XD-MD. One solid, one with hole.	N/A	
LED-CHL-XD-MD-MC	(2) Mounting clips for LED-CHL-XD-MD	N/A	

MINI DEEP FLANGED

LED-CHL-XD-MD-F	Mini deep format flanged extruded channel with flange. Includes snap-on frosted lens with mounting clips and screws.	4'	
LED-CHL-XD-MD-F-WH	Mini deep format flanged extruded channel with flange. Includes snap-on frosted lens with mounting clips and screws. White.	4'	
LED-CHL-XD-MD-F-B	Mini deep format flanged extruded channel with flange. Includes snap-on frosted lens with mounting clips and screws. Black.	4'	
LED-CHL-XD-MD-F-6	Mini deep format extruded flanged channel with flange. Includes snap-on frosted lens with mounting clips and screws.	6'	
LED-CHL-XD-MD-F-6-WH	Mini deep format extruded flanged channel with flange. Includes snap-on frosted lens with mounting clips and screws. White.	6'	
LED-CHL-XD-MD-F-6-B	Mini deep format extruded flanged channel with flange. Includes snap-on frosted lens with mounting clips and screws. Black.	6'	
LED-CHL-XD-MD-F-DC	(2) Drywall mounting brackets for LED-CHL-XD-MD-F	N/A	
LED-CHL-XD-MD-F-EC	(2) End caps for LED-CHL-XD-MD-F. One solid, one with hole.	N/A	

LTR-S Specification Series

1.5W / 3W COB (Chip On Board) LED Tape Specification Sheet



COMPATIBLE CHANNELS- FIT CONNECTORS ON PG. 1

45° ANGLE MOUNT

Catalog No.	Description		Dimensions
LED-CHL-45	Extruded angled (45°) channel. Includes snap-on frosted lens with mounting clips and screws.	4'	
LED-CHL-45-EC	(2) End caps for LED-CHL-45 - one solid, one with hole	N/A	
LED-CHL-45-MC	(2) Mounting clips and screws for LED-CHL-45	N/A	

45° LARGE ANGLE MOUNT

LED-CHL-45-1200	Extruded angled (45°) channel. Includes snap-on frosted lens with mounting clips and screws.	4'	
LED-CHL-45-1200-EC	(2) End caps for LED-CHL-45 - one solid, one with hole	N/A	
LED-CHL-45-1200-MC	(2) Additional mounting clips for LED-CHL-45-1200	N/A	

WIDE

LED-CHL-W	Wide format extruded channel. Includes snap-on frosted lens with mounting clips and screws.	4'	
LED-CHL-W-6	Wide format extruded channel. Includes snap-on frosted lens with mounting clips and screws.	6'	
LED-CHL-W-AMC	(2) Adjustable mounting brackets for LED-CHL-W	N/A	
LED-CHL-W-EC	(2) End caps for LED-CHL-W - one solid, one with hole.	N/A	
LED-CHL-W-MC	(2) Additional mounting clips for LED-CHL-W	N/A	

MUD IN - STANDARD

LED-CHL-MI-ST6	Standard extruded aluminum mud-in channel. Includes snap-on frosted lens.	6'	
LED-CHL-MI-ST-EC	(2) End caps for LED-CHL-MI-ST6 one solid, one with hole.	N/A	

STANDARD STRAIGHT

LED-CHL2-4-CA	Silver channel, white lens (2) mounting clips, (2) screws	4'	
LED-CHL2-4-WH	White channel, white lens (2) mounting clips, (2) screws	4'	
LED-CHL2-4-BK	Black channel, white lens (2) mounting clips, (2) screws	4'	
LED-CHL2-6-CA	Silver channel, white lens, (4) mounting clips, (4) screws	6'	
LED-CHL2-6-WH	White channel, white lens, (4) mounting clips, (4) screws	6'	
LED-CHL2-6-BK	Black channel, white lens, (4) mounting clips, (4) screws	6'	
LED-CHL2 LENS-4-BK	Lens in black for LED-CHL2-4	4'	
LED-CHL2 LENS-6-BK	Lens in black for LED-CHL2-6	6'	
LED-CHL2-ECG	(2) End caps for LED-CHL2-CA: light gray, one solid, one with hole	N/A	
LED-CHL2-ECW	(2) End caps for LED-CHL2-WH: white, one solid, one with hole	N/A	
LED-CHL2-ECB	(2) End caps for LED-CHL2-BK: black, one solid, one with hole	N/A	
LED-CHL2-MC	(2) Mounting clips and (2) screws	N/A	
LED-CHL2-AMC	(2) Adjustable mounting clips and (2) screws	N/A	

LTR-S Specification Series

1.5W / 3W COB (Chip On Board) LED Tape Specification Sheet



COMPATIBLE CHANNELS - SOLDERED LEADS ONLY

STANDARD STRAIGHT

Catalog No.	Description		Dimensions
LED-CHL	Extruded channel. Includes snap-on frosted lens with mounting clips and screws.	4'	
LED-CHL-6	Extruded channel. Includes snap-on frosted lens with mounting clips and screws.	6'	
LED-CHL-AMC	(2) Adjustable mounting brackets for LED-CHL	N/A	
LED-CHL-EC	(2) End caps for LED-CHL - one solid, one with hole.	N/A	
LED-CHL-MC	(2) Additional mounting clips for LED-CHL	N/A	

45° MINI ANGLE MOUNT

LED-CHL-45-MINI	Extruded angled (45°) silver channel. Includes snap-on white lens with (2) mounting clips and (2) screws.	4'	
LED-CHL-45-MINI-B	Extruded angled (45°) black channel. Includes snap-on white lens with (2) mounting clips and (2) screws.	4'	
LED-CHL-45-MINI-EC	(2) End caps for LED-CHL-45-MINI: light gray, one solid, one with hole	N/A	
LED-CHL-45-MINI-EC-B	(2) End caps for LED-CHL-MINI-B: black, one solid, one with hole	N/A	
LED-CHL-45-MINI-MC	(2) Mounting clips and (2) screws for LED-CHL-45-MINI	N/A	
LED-CHL-45-M-LENS-BK	Lens in black for LED-CHL-45-MINI	4'	

LTR-S Specification Series

1.5W / 3W COB (Chip On Board) LED Tape Specification Sheet



SHWC LUXCONTROL WIFI CONTROLLER

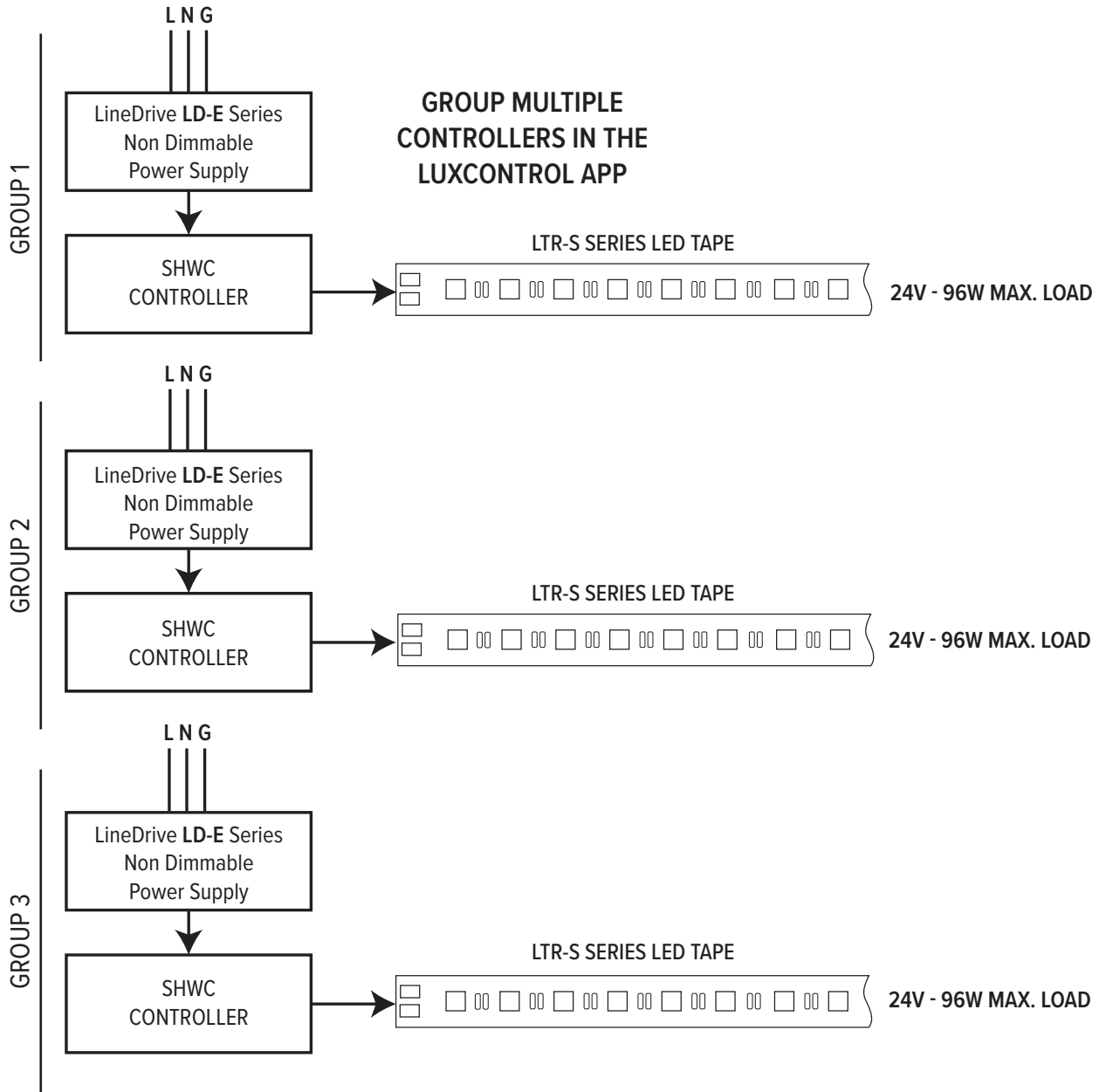

LTR-S Specification Series

1.5W / 3W COB (Chip On Board) LED Tape Specification Sheet



SHWC LUXCONTROL WIFI CONTROLLER WITH POWER REPEATER

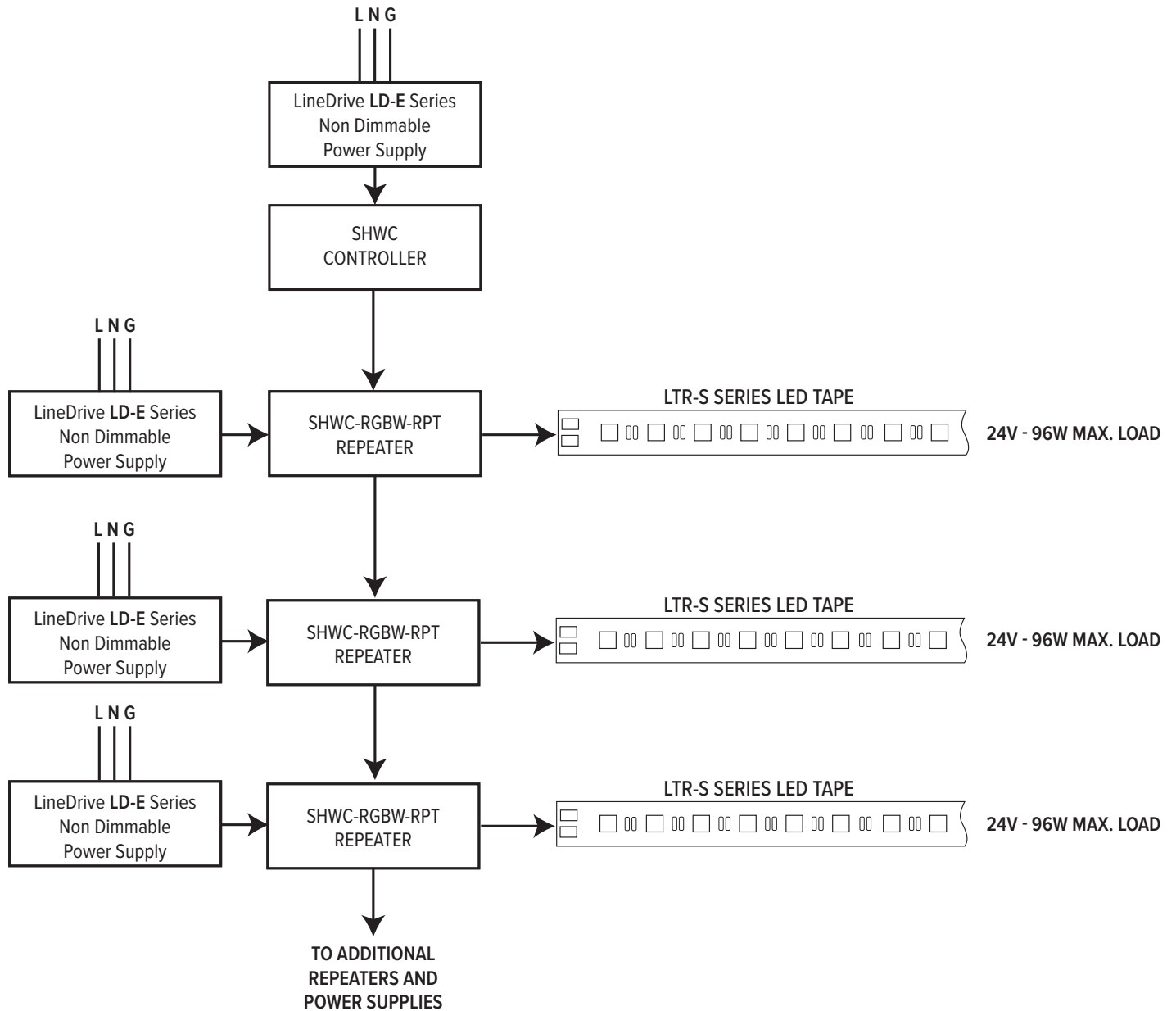

LTR-S Specification Series

1.5W / 3W COB (Chip On Board) LED Tape Specification Sheet



SHWD LUXCONTROL WIFI DIMMER

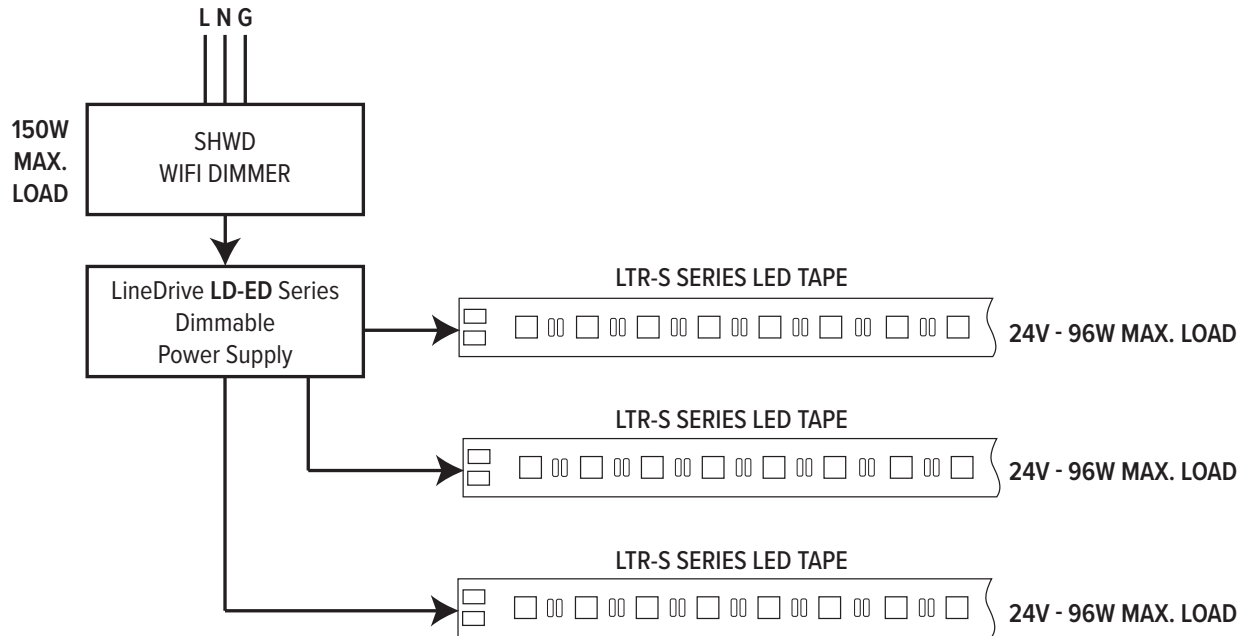

SWITCHLD SWD DRIVER AND DIMMER

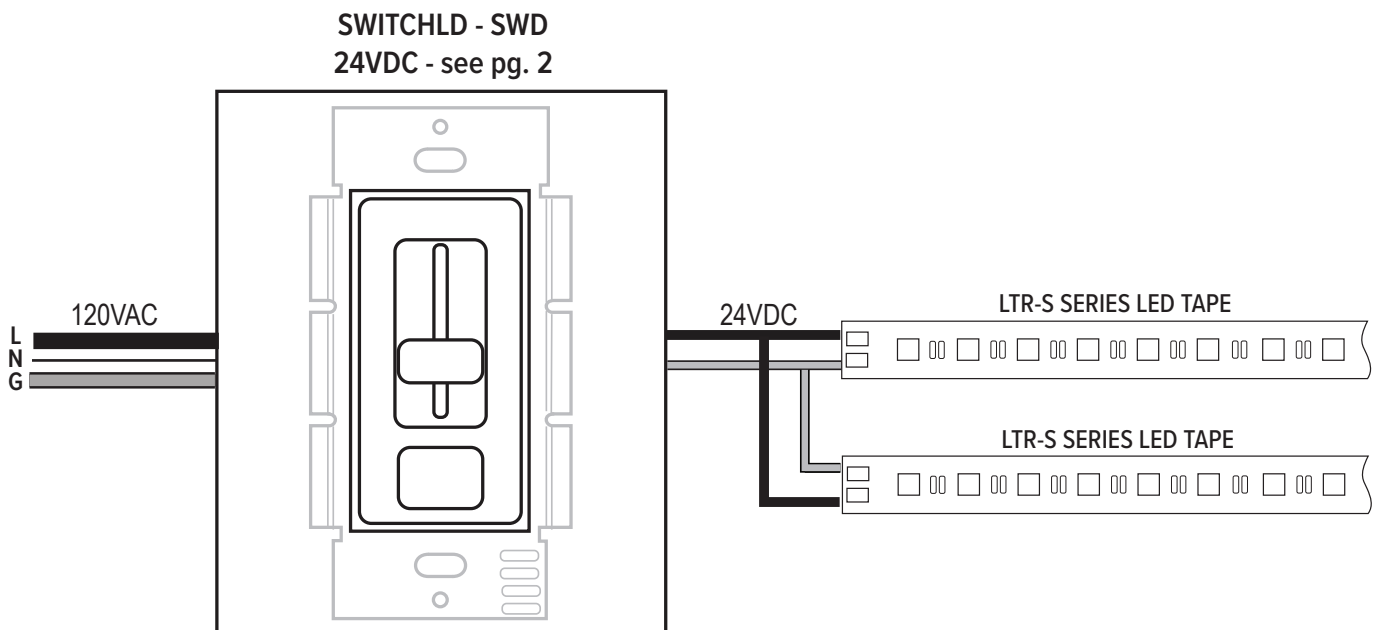

LTR-S Specification Series

1.5W / 3W COB (Chip On Board) LED Tape Specification Sheet



RF CONTROLLER

Incoming power for (L N G) options can be 120V or 277V.
 Check power supply for proper input voltage and output power required.
 Power Supply output voltage must match LED operating voltage. (24VDC)
 Power supply used **MUST NOT BE DIMMED** at the input to properly power the controls.
 See Controller instructions for pairing and wiring details.

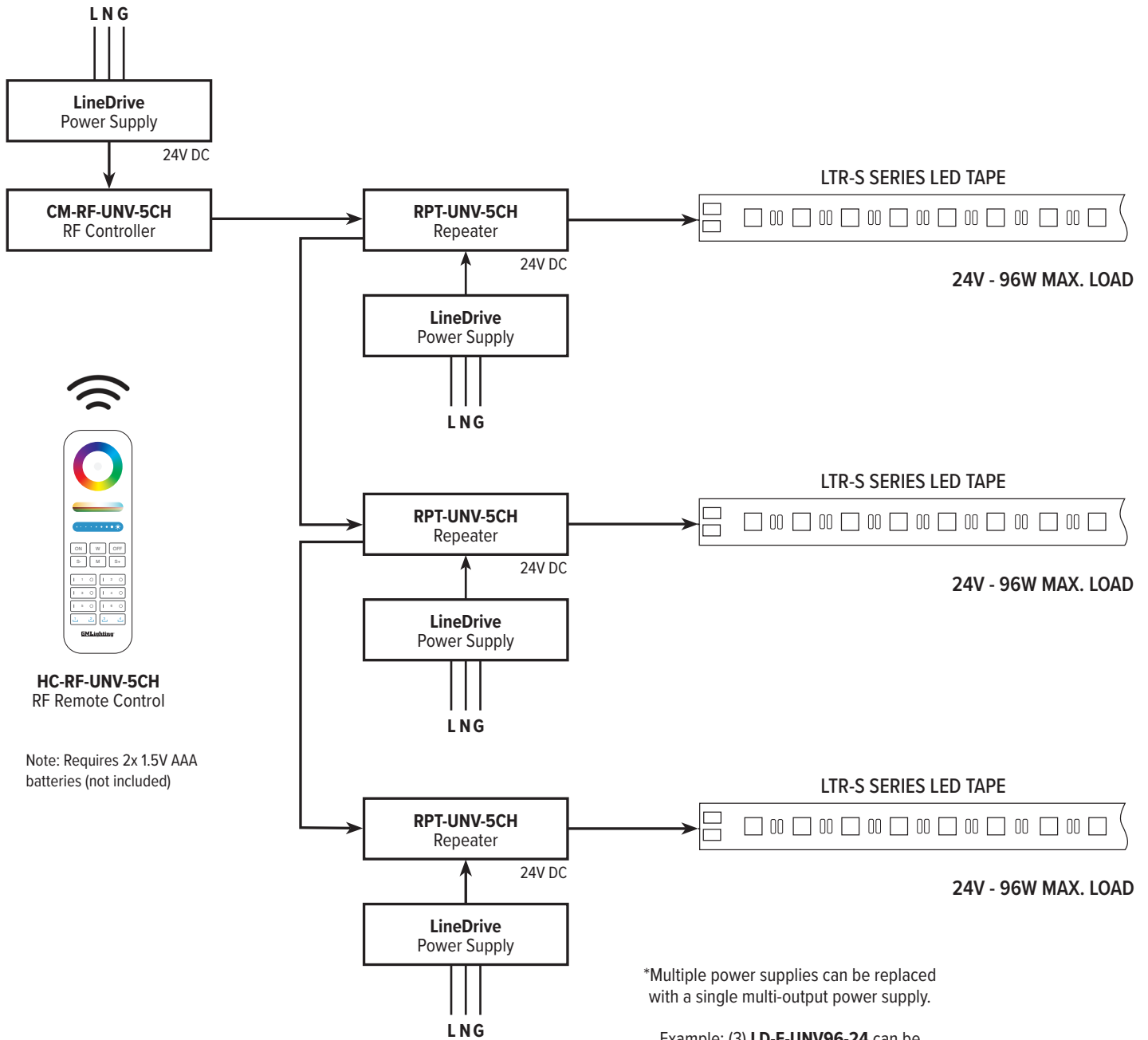

*Multiple power supplies can be replaced with a single multi-output power supply.
 Example: (3) LD-E-UNV96-24 can be replaced by (1) LD-E-UNV300-24

LTR-S Specification Series

1.5W / 3W COB (Chip On Board) LED Tape Specification Sheet



RF REMOTE CONTROLLER AND REPEATER

Use 12V or 24V dc to match LED voltage

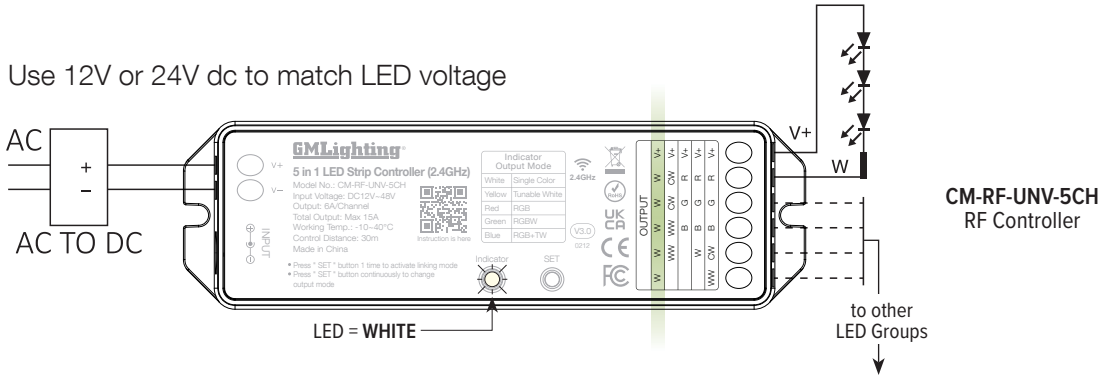

DIMENSIONS

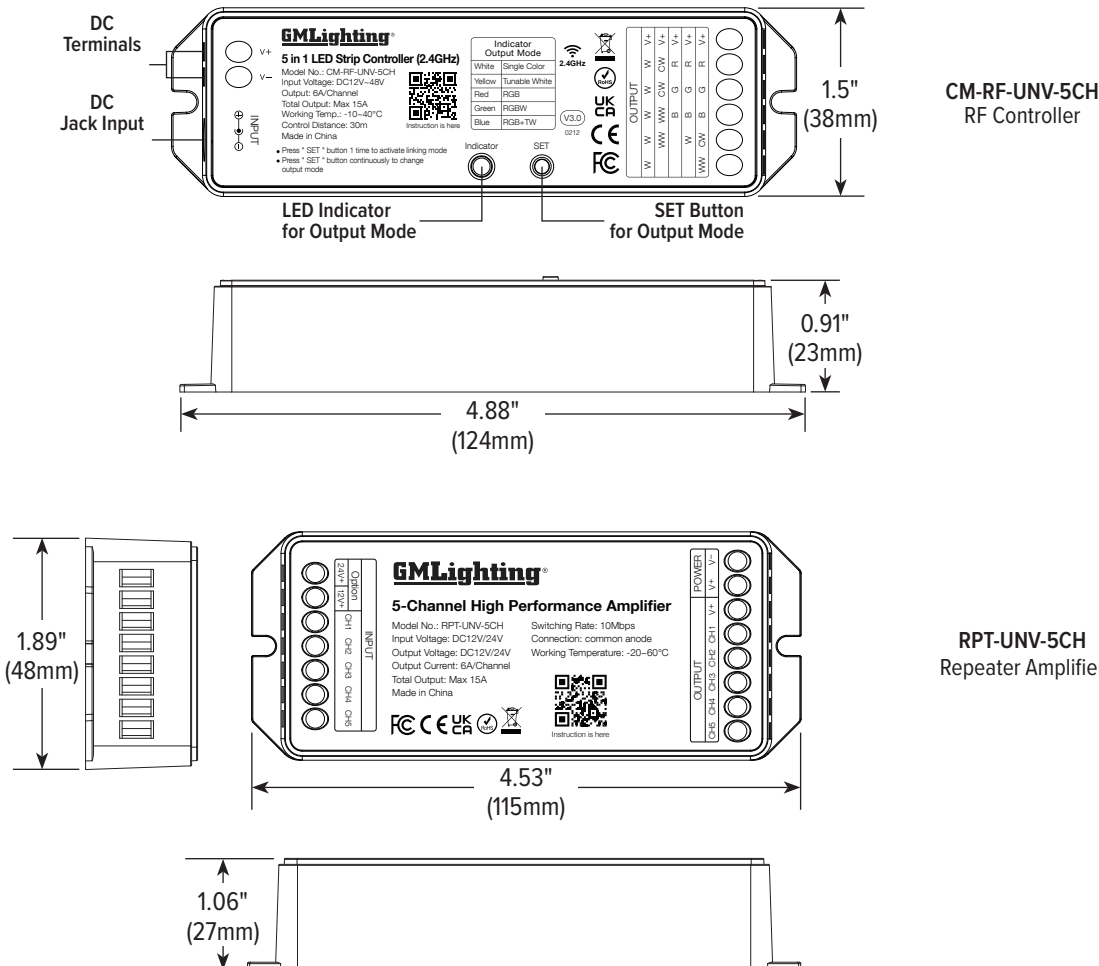

LTR-S Specification Series

1.5W / 3W COB (Chip On Board)
LED Tape Specification Sheet



RF HAND HELD REMOTE FEATURES AND DIMENSIONS

RF Remote Control
HC-RF-UNV-5CH
with Built-In Effects

