

CUSTOMER REFERENCE DRAWING

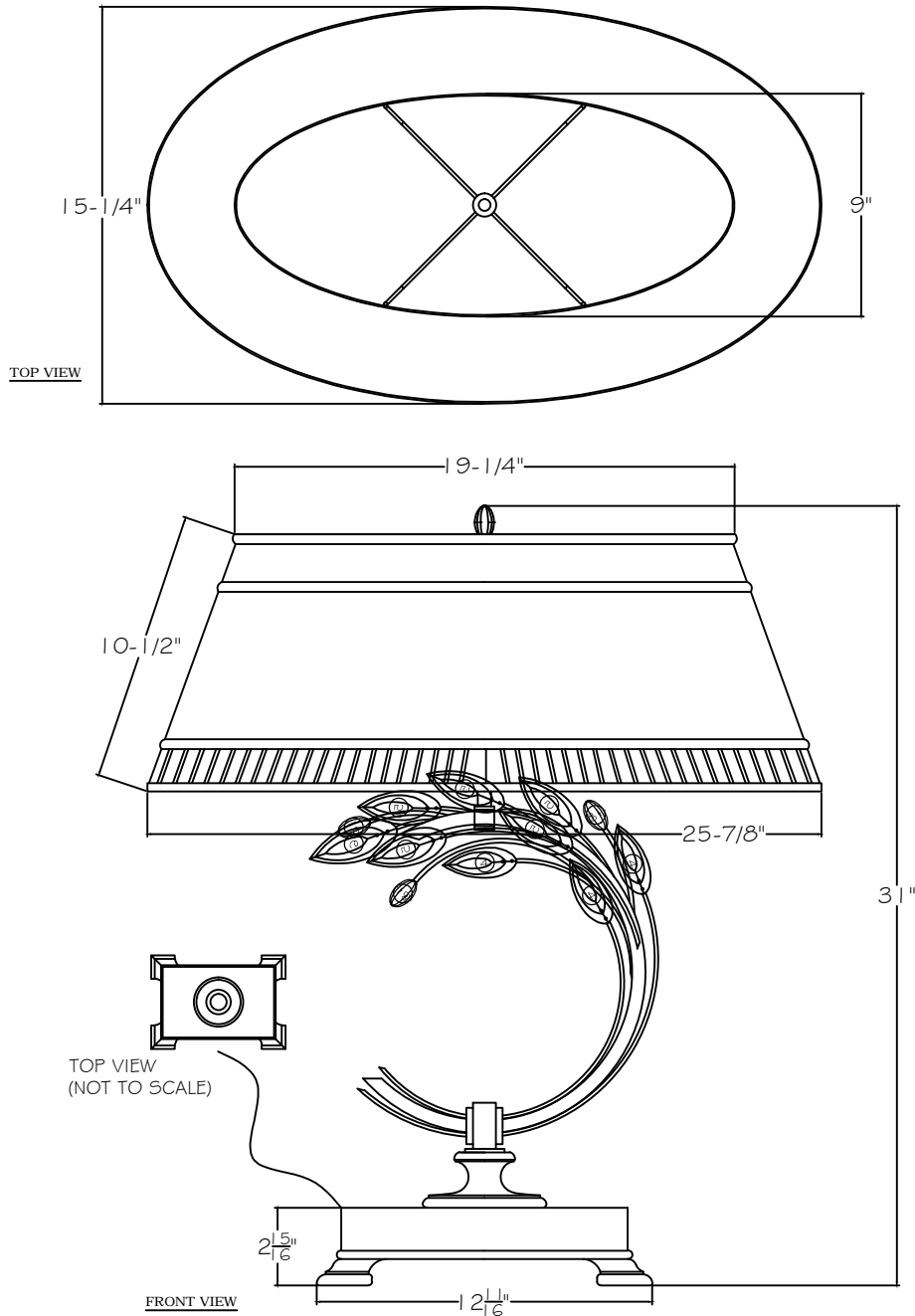

THUMBNAIL IMAGES OF STYLE OPTIONS:

-1ST SILVER

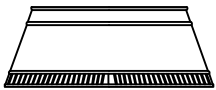

TAPERED SHADE

773210 - GOLD

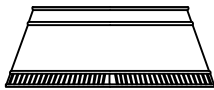

TAPERED SHADE

-SF41 SILVER

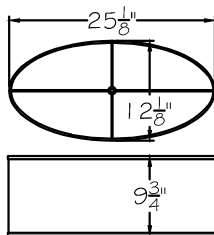

WHITE SHADE

-SF42 SILVER

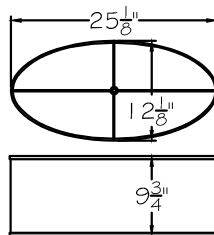

BLACK SHADE

-SF33 GOLD

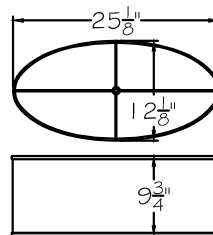

BEIGE SHADE

-SF34 GOLD

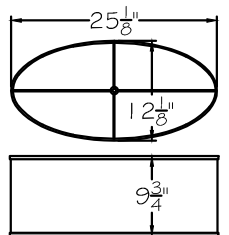

BLACK SHADE



This drawing, specifications and the product depicted are the exclusive property of Fine Art Handcrafted Lighting®. In compliance with US copyright and patent requirements, notice is hereby given that this document and the product depicted shall not be copied, altered or used in any manner without the expressed written consent of Fine Art Handcrafted Lighting®.

www.finearthl.com

Tel: (305) 821-3850  
FINE ART LAMPS®

Fax: (305) 513-5736

STYLE NUMBER:

771510

DATE:

4/17/2020